



**QAA70**  
**Room Unit**  
**Basic Documentation**



# Contents

1	Summary .....	5
1.1	Brief description.....	5
1.2	Functions .....	5
1.3	Product range .....	5
1.4	Field of use .....	5
1.4.1	Target market .....	5
1.4.2	Types of houses and buildings .....	6
1.4.3	Types of heating plants .....	6
1.5	Product liability .....	6
2	Handling .....	6
2.1	Engineering and mounting.....	6
2.2	Electrical installation .....	7
2.2.1	Regulations for installation .....	7
2.2.2	Connection diagrams.....	7
2.3	Commissioning .....	8
2.4	Display and operating elements .....	8
2.4.1	Operating elements .....	8
2.4.2	Display.....	8
2.5	Operation.....	9
2.5.1	Selecting the operating mode.....	9
2.5.2	Info button.....	9
2.5.3	Temperature readjustments .....	10
2.5.4	Presence button .....	10
3	Parameter settings for the end-user .....	11
3.1	General.....	11
3.2	Setting the temperatures .....	11
3.3	Heating program.....	12
3.4	Setting the time of day.....	12
3.5	Actual values .....	12
3.6	Holiday function .....	13
3.7	Retrieving the default values .....	13
3.8	Default values.....	13
3.9	Status displays .....	14
4	Operation by the heating engineer .....	14
4.1	Activating the service and parameter setting level .....	14
4.2	Settings.....	14
4.3	Leaving the service and parameter setting level .....	15

5	Example of plant .....	16
6	Technical data.....	17
7	Dimensions .....	18

# 1 Summary

## 1.1 Brief description

---

The QAA70 is a digital, multi-functional room unit designed to enhance room comfort and the functions of the following types of heating controllers and boiler management units:

- RVP digital of the D-series
- RVP54...
- ALBATROS™ controllers type RVA...
- LGM11...

The room unit enables all key functions to be controlled from the living room.

## 1.2 Functions

---

Ergonomic and function-specific operating levels and clear assignment of the basic functions:

- Operating mode, setpoint readjustment and presence button are directly accessible
- Various actual values can be called up with the Info button
- Additional functions can be parameterized after opening the cover
- Specific service level with protected access
- Every setting or change is shown on the display and thus acknowledged
- Heating program with up to three heating periods per day (can be individually selected)
- Holiday program
- Possibility of resetting the heating program to the default values
- Programming lock (protection against tampering)
- Additional connection facility for:
  - One remote temperature sensor, or for
  - Changing the operating mode via the telephone network using an external switch, or for
  - Changing the operating mode via a window switch
- Minimum backup of 12 hours; individually programmed values remain stored in non-volatile memory
- Elegant housing made of recyclable plastic

## 1.3 Product range

---

Room unit QAA70

Remote room temperature sensor QAW44...

## 1.4 Field of use

### 1.4.1 Target market

---

The QAA70 room unit has been designed for the OEM market. It is delivered directly to the boiler manufacturer and is conceived to enhance the functions and the operation of boiler temperature controllers.

## 1.4.2 Types of houses and buildings

---

The room unit is suited for the following types of houses and buildings, depending on the type of controller with which it is used:

- Single- and two-family houses
- Smaller multi-family houses
- Holiday houses and villas
- Small commercial buildings

## 1.4.3 Types of heating plants

---

Suitable for all standard heating systems, such as radiators, convectors, underfloor and ceiling heating systems. Especially suited for heating plants that use a pump heating circuit.

## 1.5 Product liability

---

- The room unit may only be used in building services plant and applications as indicated above
- When using the unit, all requirements specified in "Technical data" must be observed
- Local regulations for electrical installations must be complied with

# 2 Handling

## 2.1 Engineering and mounting

---

- The QAA70 room unit should be mounted in the main living room
- The unit should be sited such that its sensor can acquire the room temperature as accurately as possible. This means that it should not be exposed direct solar radiation nor should it be affected by heat or refrigeration sources
- Mounting height is about 1.5 m above the floor
- The room unit fits on most commercially available recessed conduit boxes or can be mounted directly on the wall

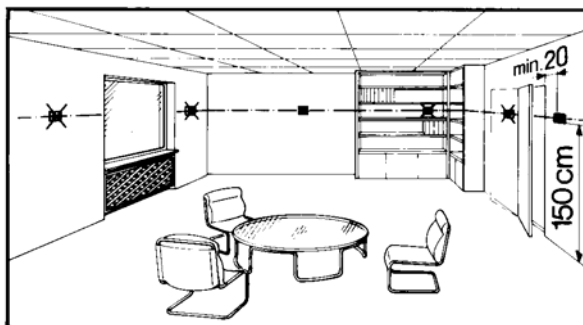

## 2.2 Electrical installation

### 2.2.1 Regulations for installation

First, mount and wire the base. Then, engage the unit at the bottom, swing it upward and let it snap on.

The electrical installation must be made in compliance with local regulations.

### 2.2.2 Connection diagrams

Example 1

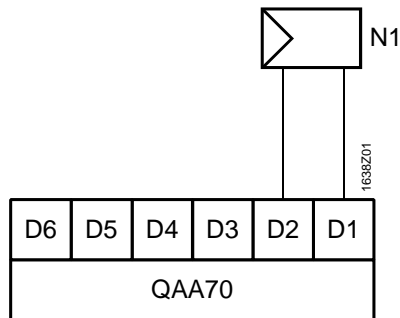

Controller N1 with QAA70 room unit

Example 2

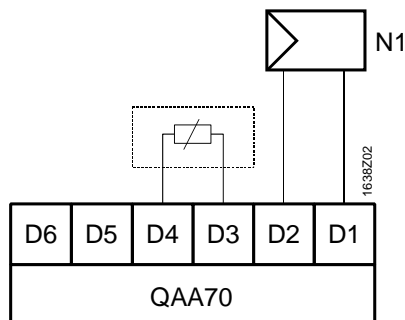

Controller N1 with QAA70 room unit and remote sensor  
(room unit terminals D3 / D4)

Example 3

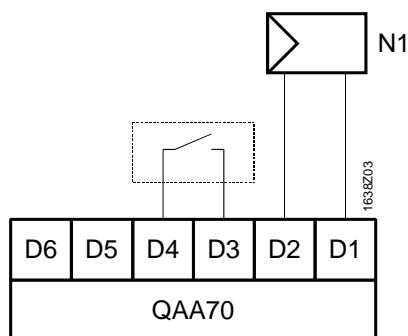

Controller N1 with QAA70 room unit and remote telephone switch  
(room unit terminals D3 / D4)

#### Note

PPS connections between controller and room unit are interchangeable.

#### Caution

External voltage may not be fed to terminals D3, D4 and D5!

## 2.3 Commissioning

The room unit will automatically be switched on as soon as power is present. If required, the heating engineer can change the parameter settings to meet individual needs.

### Tips on commissioning

If, with weather compensation and room temperature influence (controller setting), the room is equipped with a thermostatic radiator valve, the latter must be locked in its fully open position, thus ensuring maximum flow through the radiator.

## 2.4 Display and operating elements

### 2.4.1 Operating elements

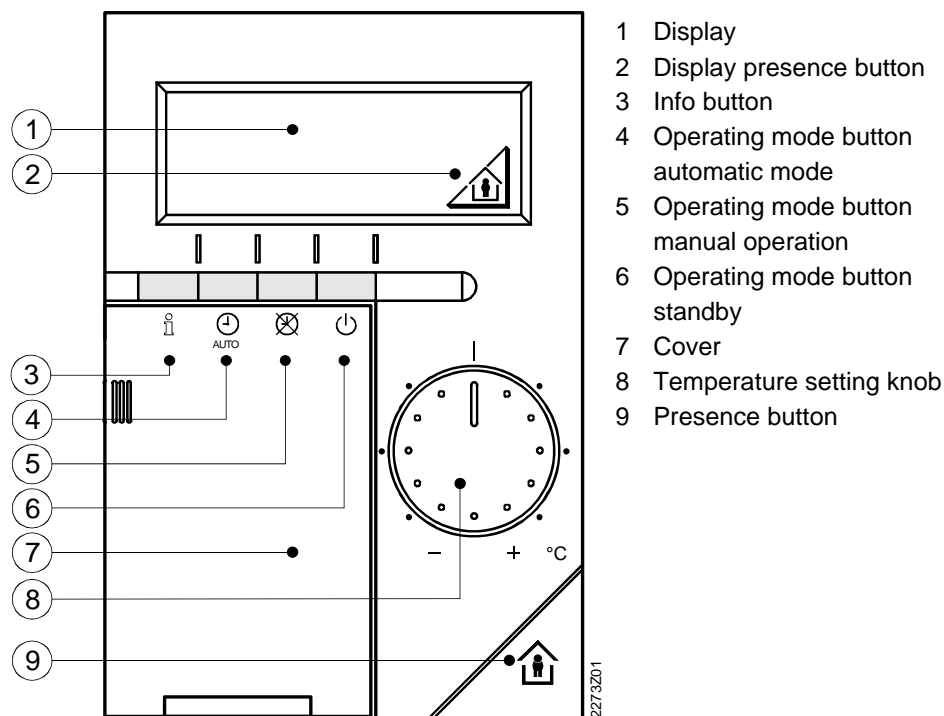

### 2.4.2 Display

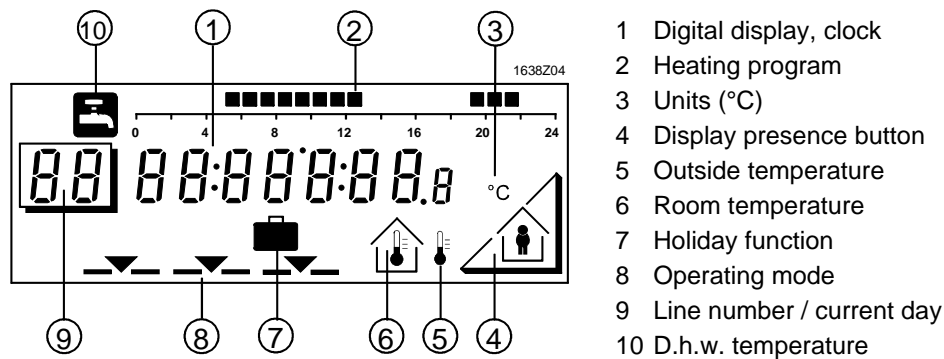





## 2.5 Operation

During operation, the unit cover must be closed!

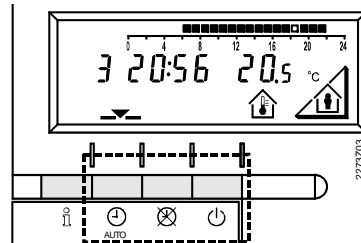
### 2.5.1 Selecting the operating mode



Press the required operating mode button. The display will show your choice as 



AUTO

#### Automatic mode

The heating operates automatically according to the selected heating program. The program can be temporarily overridden by pressing the presence button.



#### Manual operation

The heating system is operated manually, depending on the choice made with the presence button



#### Standby

The heating is switched off. Frost protection is ensured.

Note

The above selections do not affect the d.h.w. operating mode.

### 2.5.2 Info button

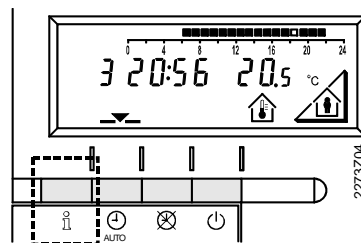

When the Info button is pressed, the display shows the following values in successive order:



Weekday, time of day, room temperature



Weekday / time of day



Outside temperature \*

\* This display appears only if the respective sensor is connected

Note

The room unit continues to operate independent of the selected display.

## 2.5.3 Temperature readjustments

Before making any room temperature readjustments on the room unit, thermostatic radiator valves – if present – must be set to the required temperature!

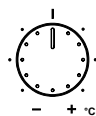

If it is too warm or too cold in your apartment, you can turn the temperature setting knob to change the nominal room temperature.





If you turn the setting knob toward +, you raise the nominal temperature 1 °C per graduation.



If you turn the setting knob toward -, you lower the nominal temperature by 1 °C per graduation.

Before making any new readjustments, wait some time, allowing the room temperature to adapt.

Note:

With the temperature setting knob, you only readjust the nominal room temperature. The reduced room temperature will not be changed. The temperature is displayed only if the room temperature controller operates in automatic mode  or with manual operation .

## 2.5.4 Presence button

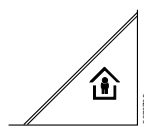

If you do not use your rooms for longer periods of time, you can press the presence button, thus saving heating energy. When your rooms are occupied again, press the presence button again to provide heating.

The display shows the selection made:





Heating to the nominal temperature



Heating to the reduced temperature

Note:

In manual operation , the selection made acts continuously, in automatic mode  only until the next switching action according to the heating program takes place.

# 3 Parameter settings for the end-user

## 3.1 General

To set the parameters of the QAA70, the unit cover must be open!

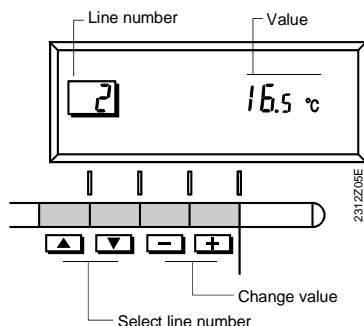

As soon as the cover is opened, the display and the button function will change. Then, the framed number indicates the program lines that can be selected with the arrow buttons and .

You can set or display the following values:

- Temperatures to
- Heating program to
- Weekday and clock to
- Current values to
- Duration of the holiday period
- Resetting to the default values

## 3.2 Setting the temperatures

Before making any room temperature readjustments on the controller, thermostatic radiator valves – if present – must be set to the required temperature!

In automatic mode, the controller switches between nominal and reduced room temperature according to the heating program.

- Nominal temperature:** Room temperature during room **occupancy** times (basic setting)
- Reduced temperature:** Room temperature during **absence** or in the night
- D.h.w. temperature:** Required d.h.w. temperature. (only for controllers with d.h.w. function)

### 3.3 Heating program

With the heating program, you can predetermine the temperature changeover times for one week.

The seven-day program consists of a seven-day block (1-7) in which every day uses the same program, or single days (1...7) with seven individual 24-hours programs (1 = Monday...7 = Sunday). Each 24-hours program offers three heating periods each of which is defined by a start and an end time.

If you do not require a certain heating period, you need to enter the same time of day as the start and the end time.

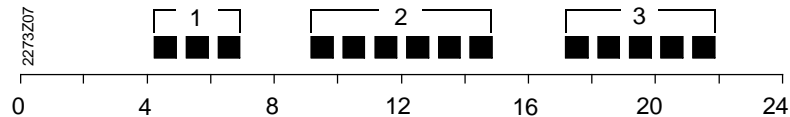

- 4** Select the respective day for the heating period. You have the choice of the seven-day block (1-7) and of individual days (1...7) (1 = Monday ...7 = Sunday)
- 5** Start of heating period 1: heating to the nominal temperature
- 6** End of heating period 1: heating to the reduced temperature
- 7** Start of heating period 2: heating to the normal temperature
- 8** End of heating period 2: heating to the reduced temperature
- 9** Start of heating period 3: heating to the normal temperature
- 10** End of heating period 3: heating to the reduced temperature

### 3.4 Setting the time of day

- 11** For setting the current weekday (1 = Monday...7 = Sunday).
- 12** For setting the current hour and minute

With **-** and **+**, you set the correct time of day. Continuous pressing of these buttons accelerates the display.

### 3.5 Actual values

- 13** Display of the actual d.h.w. temperature
- 14** Display of the actual boiler temperature
- 15** Display of the actual flow temperature

## 3.6 Holiday function

**16** For entering the number of days during which you will be absent.

The display shows the holiday symbol () , the first day of the holiday period on the left (1 = Monday...7 = Sunday), and the number of days of the holiday period on the right



During the holiday period, the controller switches to standby





At the end of the holiday period, the controller switches to the automatic mode

Note:

The holiday function can be cancelled by pressing any of the operating mode buttons.



## 3.7 Retrieving the default values

**17** To retrieve the default values, press  and  for at least 3 seconds. As a confirmation, the display shows **!**





Caution!

In that case, the values of the following line numbers that have previously been entered will be lost!

- Temperature and time program  to 
- Duration of the holiday period 

## 3.8 Default values

Designation		Value	Unit
Nominal temperature		20	°C
Reduced temperature		14	°C
D.h.w. temperature		60	°C
Working day program (days 1-5)	ON OFF ON OFF ON OFF	06:00 22:00 24:00 24:00 24:00 24:00	hh:mm
Weekend program (days 6-7)	ON OFF ON OFF ON OFF	08:00 23:00 24:00 24:00 24:00 24:00	hh:mm

## Status display

No display:



- No power at the heating controller
- Faulty connection between room unit and heating controller
- Room unit and heating controller not compatible
- Room unit faulty

Display:



- Programming lock active
- Heating controller's operating mode is not set to manual operation 

Display:

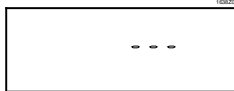

- No sensor connected or sensor faulty

Display:



- Remote telephone switch (external contact) active

Display flashes:







- Room unit is in the initialization phase (rotating circle)

## 4 Operation by the heating engineer

The QAA70 room unit has a service and parameter setting level to give the heating engineer additional setting choices. This level can only be activated by pressing a certain combination of buttons.

### 4.1 Activating the service and parameter setting level

Keep buttons  and  depressed for at least 5 seconds. This will activate the service and parameter setting level.

Then, press the same arrow buttons to select the individual entry line and adjust the values by pressing  or .

### 4.2 Settings

**Device address for the PPS interface**



This line is used for setting the PPS address (for QAA70 room units connected to RVA... controllers, default address 1 should not be changed)

The display shows the status of the PPS:

- Colon flashing at one-second intervals: communication o.k.
- Steady or missing colon: ready to communicate
- Steady hyphens: communication interrupted

**Device identification**



The display shows the identification number and the software-version.

<b>Programming lock end-user level 2</b>	<p><b>53</b> When activating the programming lock (parameter 53 = 1), all parameters can be displayed but not changed. When pressing <b>-</b> or <b>+</b>, the display will show <b>OFF</b>.</p>
<b>Caution!</b>	<p>The operating lock can temporarily be deactivated. This is accomplished by simultaneously pressing <b>▲</b> and <b>+</b> for at least 5 seconds. To cancel the operating lock permanently, parameter 53 must be set to 0.</p>
<b>Function of input D3/D4</b>	<p><b>55</b> The freely programmable input (terminals D3 and D4) permits the application of three different functions. The parameter has the following meaning:</p> <ul style="list-style-type: none"> <li>1 = connection of an external sensor type QAW44; the display shows the temperature acquired by the external sensor (- = no sensor connected, function deactivated)</li> <li>2 = using an external contact, changeover to the reduced temperature can be accomplished; the display shows the current status of the external contact (<b>ooo</b> = contact CLOSED, - - - = contact OPEN)</li> <li>3 = using an external contact, changeover to the frost protection temperature can be accomplished; the display shows the current status of the external contact (<b>ooo</b> = contact CLOSED, - - - = contact OPEN)</li> </ul> <p>AL = this function is not used</p>
<b>Operating action of external contact</b>	<p><b>56</b> If input D3/D4 is connected to an external potential-free contact (parameter 55 = 2 or 3), the operating action of the contact (remote telephone switch or window switch) can be selected; the operating action designates the contact status at which the required function is active.</p> <p>Display:     <b>ooo</b> = contact CLOSED               - - - = contact OPEN</p>
<b>Influence of external room temperature sensor</b>	<p><b>57</b> Determines the mixing ratio of internal and external room temperature sensor if parameter 55 = 1.</p> <ul style="list-style-type: none"> <li>0 % = internal sensor only (0 % external, 100 % internal)</li> <li>50 % = mean value of external and internal sensor</li> <li>100 % = external sensor only</li> </ul> <p>For room temperature control and the display, the adjusted mix is used. If the external sensor is affected by a short-circuit or an open-circuit, the internal sensor will be used to ensure operation.</p>
<b>Display of setpoint</b>	<p><b>58</b> This setting switches programming lines 1 and 2 (normal/reduced temperature) from the absolute display of the temperature to the relative display.</p>

### 4.3 Leaving the service and parameter setting level

When closing the unit cover, the service and parameter level will be quit and the settings made stored.

## 5 Example of plant

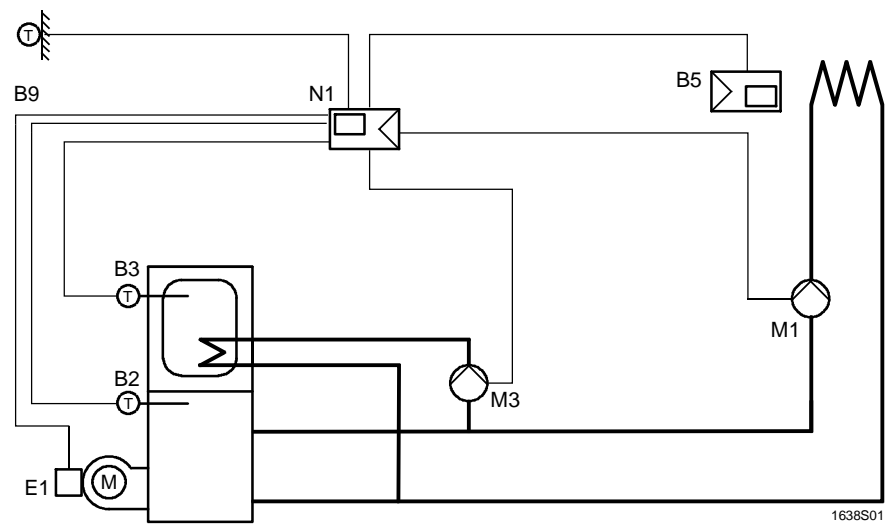

- B2 Boiler temperature sensor
- B3 D.h.w. temperature sensor
- B5 Room unit QAA70
- B9 Outside sensor
- E1 Burner
- M1 Heating circuit pump
- M3 D.h.w. charging pump
- N1 Controller



## 6 Technical data

Nominal frequency	50...60 Hz	
Overvoltage protection		
Max. permissible voltage	DC 24 V	(terminals D1/D2)
	-13...5 V	(terminals D3/D4)
Safety class to EN 60730	III	
Degree of protection to EN 60529 (when mounted on a closed wall)	IP 30	
Electromagnetic compatibility		
Immunity	EN 50082-2	
Emissions	EN 50081-1	
<b>CE</b> conformity		
Electromagnetic compatibility	89/336/EEC	
Low voltage directive	73/23/EEC	
Perm. ambient conditions to IEC 721:		
Operation	3K3 (IEC 721-3-3)	0...35 °C
Transport	2K3 (IEC 721-3-2)	-25...70 °C
Storage	1K3 (IEC 721-3-1)	-25...70 °C
NTC temperature sensor:		
Time constant	10 min.	
Thermal coupling to the wall	50 %	
Permissible cable lengths		
0.25 mm <sup>2</sup>	25 m	
From 0.5 mm <sup>2</sup>	50 m	
Weight	0.22 kg	
Backup of clock	12 h	
Room temperature measurement range	0...32 °C	
Setting ranges:		
Nominal temperature	5...30 °C	
Reduced temperature	5...30 °C	
Temperature readjustment range	±3 °C	
Resolution	0.5 °C	
Ordering multiple	20 pieces	

# 7 Dimensions

## QAA70 room unit

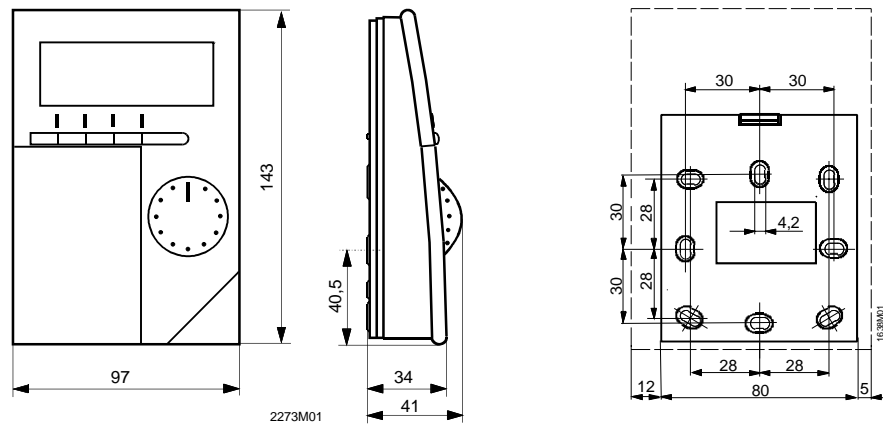

## QAW44 remote temperature sensor

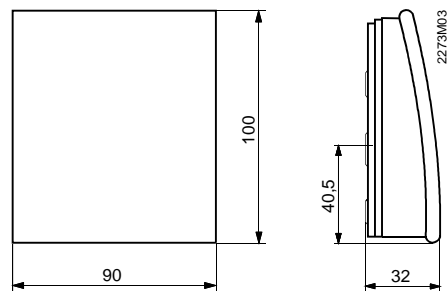

# Index

<b>A</b>		
activating parameter setting level .....	14	
activating the service .....	14	
actual values .....	12	
automatic mode .....	9	
<b>B</b>		
brief description.....	5	
<b>C</b>		
commissioning .....	8	
connection diagrams.....	7	
<b>D</b>		
default values.....	13	
display.....	8	
<b>E</b>		
electrical installation.....	7	
engineering .....	6	
example of plant.....	16	
<b>F</b>		
field of use.....	5	
<b>H</b>		
handling .....	6	
heating engineer additional setting choices .....	14	
heating program.....	12	
holiday function .....	13	
<b>I</b>		
info button .....	9	
<b>M</b>		
manual operation .....	9	
<b>O</b>		
operating elements.....	8	
operating functions.....	5	
operation .....	9	
<b>P</b>		
parameter settings .....	11	
presence button .....	10	
product liability .....	6	
product range .....	5	
<b>R</b>		
regulations for installation .....	7	
<b>S</b>		
selecting the operating mode .....	9	
setting of heating circuit .....	14	
setting the temperatures .....	11	
standby.....	9	
status display .....	14	
<b>T</b>		
technical data .....	17	
temperature readjustments .....	10	
time of day.....	12	

Siemens Building Technologies AG  
Landis & Staefa Division  
Gubelstrasse 22  
CH 6301 Zug  
Tel. 41 41-724 24 24  
Fax 41 41-724 35 22  
[www.landisstaefa.com](http://www.landisstaefa.com)

© 1999 Siemens Building Technologies AG  
Subject to alteration