

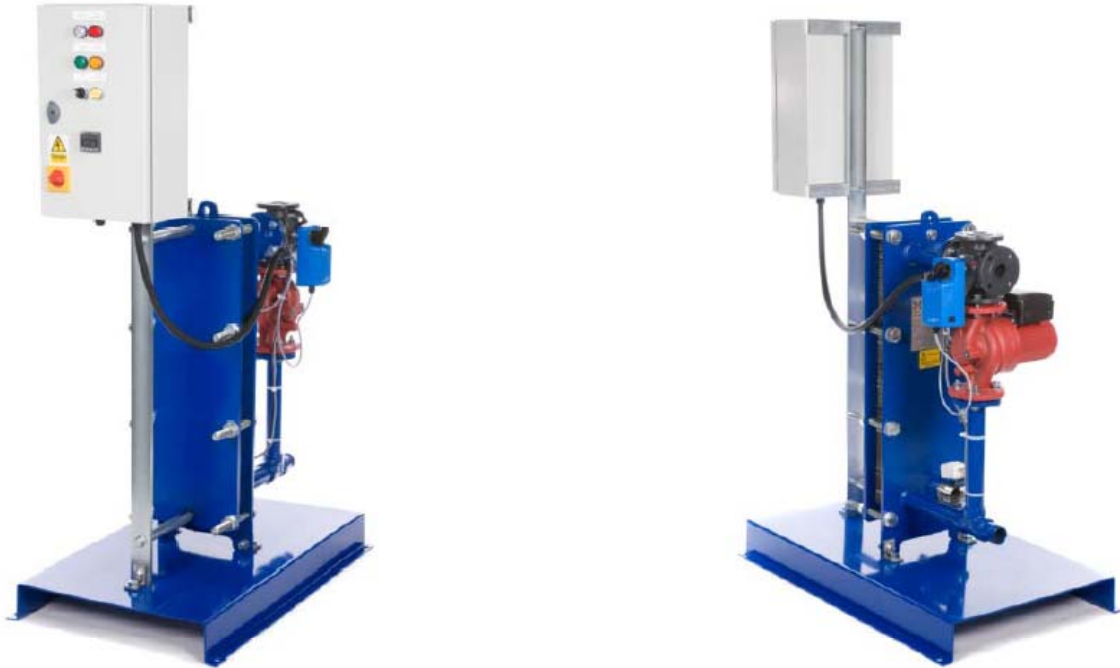

MHG HEATING LTD



Instantaneous HWS Packaged Plate Heat Exchanger. Installation and Maintenance Manual.

This manual contains essential information with regards to the safe handling, installation, operation and maintenance of the heat exchanger equipment. It is important that the relevant personnel are made aware of this document, and have fully read and understood its contents before becoming involved with heat exchangers of this type. Failure to read the manual may result in misuse, thus resulting in potential injury to personnel and damage to the equipment.

Index.

1. How it Works	3
2. Time Clock / BMS Operation	3
3. Primary Pump Energy Saving Feature	3
4. Commissioning	4
5. 4 Port Valve	5
6. Control Valve Testing	6
7. Instantaneous Hot Water Systems	7
8. Pipework Connections	10
9. Setting Up The Controller	12
10. Shutting Down the Exchanger for Maintenance	13
11. Cleaning the Plate	13
12. Assembly	14
13. Tightening of the Plate Pack	15
14. Trouble Shooting	16
15. Maintenance	19
16. Spare Parts	19
17. Controller Setting Guide	20

1. How it Works

The unit is designed to heat domestic hot water (DHW) using low temperature hot water (LTHW). The primary circulating shunt pump mounted on the exchanger is for heat exchanger control only and is sized to pump the correct volume of LTHW through the heat exchanger to ensure efficient operation.

When domestic hot water is required, the control valve modulates to allow LTHW to be pumped through the exchanger. The required DHW outlet temperature can be set on the controller. The temperature of the DHW is monitored by the strap-on sensor on the DHW outlet pipe. This sends a signal to the controller in the panel that in turn modulates the control valve thereby maintaining the DHW outlet temperature set on the controller.

If the DHW goes over temperature then an over-heat stat shuts down primary circulating pump (and also the secondary pump if fitted and controlled by the panel). The system can only be re-started when the temperature has cooled down and after the high temperature re-set button has been pushed on the front of the panel.

To avoid the possibility of thermal siphoning back from the boiler return we recommend that non return valves are incorporated into the pipe-work. Due to the high efficiency of the heat exchanger when there is no DHW circulation it is possible to overheat the DHW and cause the stat to trip even when the primary shunt pump is not running.

2. Time Clock / BMS Operation

As an additional option the unit can be supplied with either a time clock that is incorporated into the panel or Building Management System interface signals.

During control times / schedules, the pump(s) run continuously.

When in AUTO control (by either BMS or time clock) only the operation of the pump(s) is controlled. The high temperature over heat protection and the control of the modulating valve is independent of the auto pump control operation.

Four port valves are fitted as standard to all of the models in the range. Advantages of a four port valve are that it allows the LTHW circulation to be maintained to and from the unit at all times.

This:

- avoids cold pipe work when exchanger not calling for heat
- allows any other boiler safety & control functions to continue (such as over runs, etc)
- enables the exchanger to be connected into the main primary loop rather than from a "tapping" into the main primary flow and return.

3. Primary Pump Energy Saving Feature (if fitted)

As another additional option, the packaged unit can be fitted with an energy saving feature for the primary shunt pump. In times of low demand, the pump shuts down, thus saving energy. As this corresponds to the valve closing, then the boiler circuit is closed off as well, thus saving more energy from the primary heat source. The pump shuts down when the actuator is less than 4% open, and the pump starts when the actuator is more than 6% open.

The energy saving feature can be retro-fitted, but it does involve modifications to the actuator and the control panel.

4. Commissioning

As with all plant equipment, it is recommended that some commissioning takes place in order to set up the equipment correctly and to check the settings. Contact our Sales Office for commissioning rates if required.

-: 4 PORT VALVE :-

Details of setting up the 4 port valve – type ESBE VRG141

If actuator removed, then rotate the valve stem until the "notch" on the stem is pointing vertically upwards as shown

Actuator Closed Position

Actuator Open Position

Once valve in this position, turn valve stem 45 degrees clockwise (valve should stop). Switch on control panel & set temperature to 70 Deg C – actuator should move clockwise until it stops. Slip actuator onto end of valve shaft and tighten central set screw. There is a locating dowel that protrudes out of the valve that needs to lock into the back of the actuator before tightening the central screw). Re-set temperature to desired position on panel.

When valve / actuator in fully open position, then the heat exchanger is on maximum demand. When valve/actuator in fully closed position, then there is no / minimal heating of secondary water.

5. 4 PORT VALVE – Cast iron body type

Before use, or if the system has been drained down for a period of time, it is important to check the operation of the valve

– push the button slide forward on the side of the actuator – this frees the actuator drive from the valve – then rotate the valve stem from left to right (or right to left – depending upon where the valve is positioned), whilst continuing to hold the slide button forward (releasing the button locks the actuator drive back to the stem, thus preventing manual rotation).

The valve stem should rotate for about 90 degrees before coming to a stop.



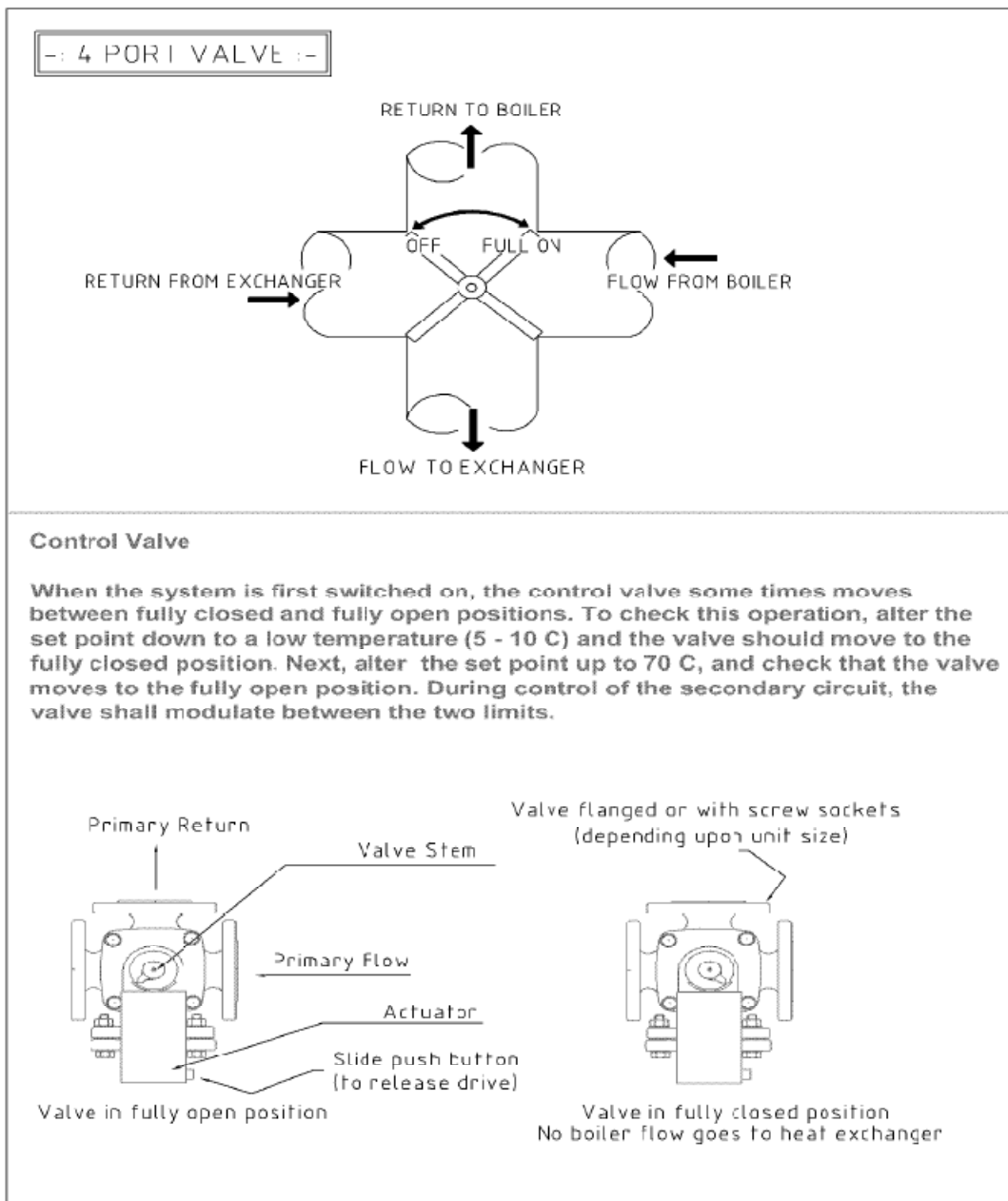

The valve stem should move relatively easily – if not, then check that slide button is being pushed forward enough, and try again. If the stem still cannot be rotated, then spray WD40 into where the valve stem goes through the valve body. If still no movement, then contact the Sales Office.



6. Control valve testing:

Once filled with water, and before use, or if the system has been drained down for a period of time, it is important to check the operation of the valve – switch on the control panel and set the temperature to a high level (temperature altered by raising the set point).

This is done by:

- press  which is too the right of the temperature display.
- The lower display will then show "SP" and the upper display will show the actual set point.
- Press  or  to change the set point to the required value.
- Finally, press  to return to normal run mode.

The actuator should slowly rotate clock wise until the valve is at the "2 O'clock" position and then stop.

Now lower the temperature (below ambient), and the actuator should rotate anti-clockwise and stop at around the "10 O'Clock" position.

If the actuator does not move, or does not turn full travel, then switch off at the panel by turning the isolation knob in the panel door.

Pull out central knob of actuator slightly (this exposes orange sleeve) – this frees the actuator drive from the valve – then rotate the knob from left to right (or right to left – depending upon where the valve is positioned).

The valve stem should rotate for about 90 degrees before coming to a stop.

The valve stem should move relatively easily. If the stem still cannot be rotated, then valve has seized.

Remove actuator and spray WD40 into where the valve stem goes through the valve body and then try rotating valve using a suitable wrench on the end of the stem.. If still no movement, then contact the Sales Office.

Re-setting actuator

– the central knob can only be pushed back in when the valve and the actuator are exactly in line – the valve has be rotated back to the same position it was in before the central knob was pulled out.

If this proves to be troublesome, remove actuator by un-screwing central set screw in the middle of the actuator knob, switch on the panel, set temperature high to force the control system to rotate actuator to fully open position, rotate valve to fully open position, install actuator and tighten screw (NOTE – ensure that the back of the actuator locks into the locating dowel protruding from the valve body) and then tighten the central screw.

It should then be possible to push back in the central knob and so covering the orange sleeve. Once done, return the control temperature back to the desired value.

7. Instantaneous Hot Water Systems

1. Installation

Water Softener:

It is **essential** to treat / soften the DHW prior to heating to reduce the build up of scale in the heat exchanger.

Consult with a water softening specialist to determine the best method of treatment for the water in your area.

Lifting: *Exercise extreme caution at all times when lifting*

Do not lift with the secondary shunt pump attached.

Lift from underneath if still on a base (pallet).

Lift off pallet using the lifting hole on the top at the plate heat exchanger (UKE14 only), or by attaching slings under or through the base plate – ensure unit is steadied during maneuvering. It is possible to lift from the top frame bar of the heat exchanger (Type 14 only) to steady the assembly – however, do not lift from the frame bar without using the lifting hole / from the base, as well.

It is also possible to attach a strap or sling around the top flanged connection pipe at F1 location (goes out to the control valve) for steadying purposes only – do not lift from this point – use only to steady the unit whilst lifting from other areas.

Avoid:

Lifting from the stainless steel threaded connections, control panel, pump, valves, or any of the pipe work and fittings not mentioned above.

Maintenance Space:

Leave a minimum of double the width of the exchanger, either side of the unit, to allow for access to the exchanger tie bolts, and to allow for removal of the heat transfer plates.

Leakage:

Gasketed Plate Heat Exchangers do have the potential to leak at some time during their life. Therefore, to avoid damage to plant room floor, electrical conduits etc., we recommend that a drip tray is placed underneath the plate pack.

Safety:

If the unit is to operate near personnel, we recommend that a metal spray shield is located over the gasketed plate pack in case of "blow out". This would avoid scalding. The surfaces of the unit, pump, valve, and pipe work become hot during operation – ensure that adequate consideration is given to personnel to protect them from burns when deciding upon the location of the unit

Welding:

Do not weld near to or on the heat exchanger or associated components.

Primary Shunt Pumps:

The pumps rely on water for cooling and lubrication. Damage will be caused if the pumps are run on a dry system.

DHW Shunt Pump:

If a DHW pump is supplied loose, the direction of the pump must be so that the water flows into the top right hand side connections (F2). Do not fit this pump until the unit has been installed in

its final position. This pump must be fitted with adequate supports so that no strain is put upon the heat exchanger connections.

Water Connections:

Use two wrenches when attaching unions to the domestic water circuit threaded stub connections. One wrench to be used to tighten the union & the other to prevent the stub end from rotating – this avoids damage to the gasket inside the unit that seals against the back on the stub connection. Use a none hardening thread sealant for best results. Threads are BS21 – taper, male. It is necessary to support the secondary pump and the pipe work as the heat exchanger connections are not designed to accept any weight being imposed upon them.

Pipe-work:

To avoid damage to the unit, to prevent failure and to ease maintenance, we recommend the following:

- Pipe-work - fully support to avoid weight/forces acting upon the unit / connections.
- The fitting of flexible couplings if the pipe work is subject to vibration.
- The pipe work is completely flushed before attaching to exchanger. The exchanger acts as an effective filter and will become blocked if pipe-work debris is allowed to enter the plate pack.
- The fitting of suitable vents, isolation valves & drains. To allow servicing of the package without complete system draining appropriate isolation valves should be fitted.
- The fitting of non return valves where appropriate
- The fitting of suitable sized pressure relief valves in the pipe work on both circuits (essential safety requirement).

Sensors:

There are two temperature sensors – one for control and the other for over heat protection. Both sensors are the strap on type, they both need to be attached tightly to the pipe work. If steel pipe work is used, then for best results we recommend that a section of steel pipe is replaced by copper, and the sensors attached to this section of copper.

Both sensors should be connected to the secondary flow pipe work going to the services (flow from F3 connection).

The control sensor needs to be attached to the pipe between 250 to 500 mm away from the exchanger, and the overheat located just after the control sensor. Route and clip the wires as necessary – do not attach any wires near, or onto the tie bolts, or along the length of the top horizontal frame bar of the heat exchanger.

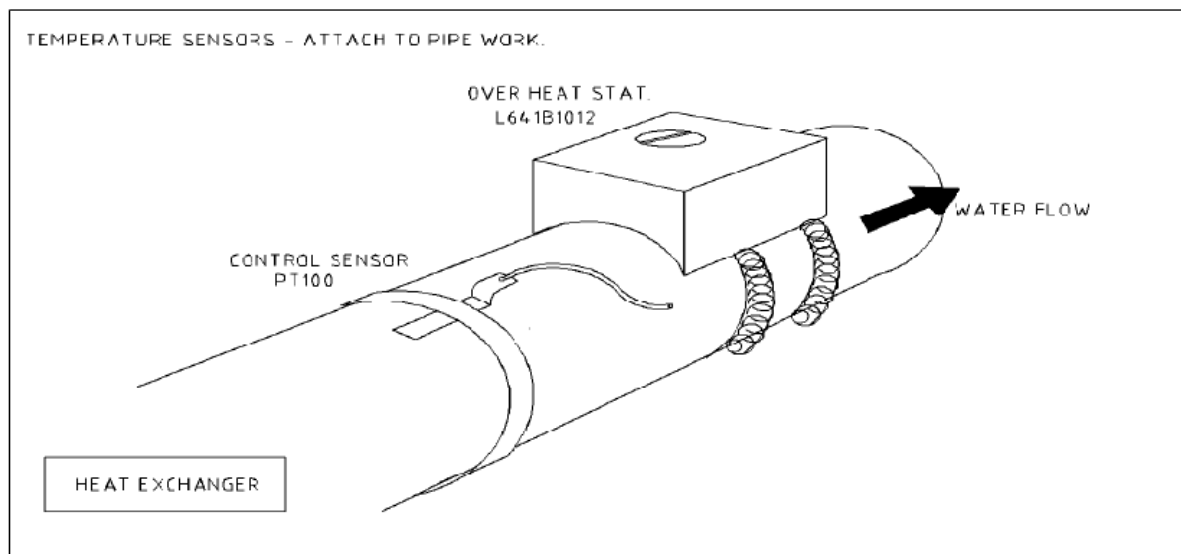

Electrical Installation:

Connect the supply cable to a suitable fused (16 amp max.) single phase electrical supply via a double pole isolation switch. The only connections required are the supply to the panel together with connection of secondary pump(s) if applicable. When a secondary pump is supplied with the package, the pump control cables are installed at the factory and clearly marked. They should be connected to the pump only after the pump has been fitted to the pipe work. All other wiring is carried out at the factory.

All wiring must be carried out by suitably qualified personnel in line with current regulations.

8. Pipe-work Connections: - Fig 1: Connection location and function.

Example shown: 8 with single headed pump
 Appearance may alter depending on model & options supplied

CONNECTIONS:

Flow from Boiler: V4
 Return to Boiler: V1
 Secondary inlet (cold return): F2
 Secondary Outlet (hot flow): F3

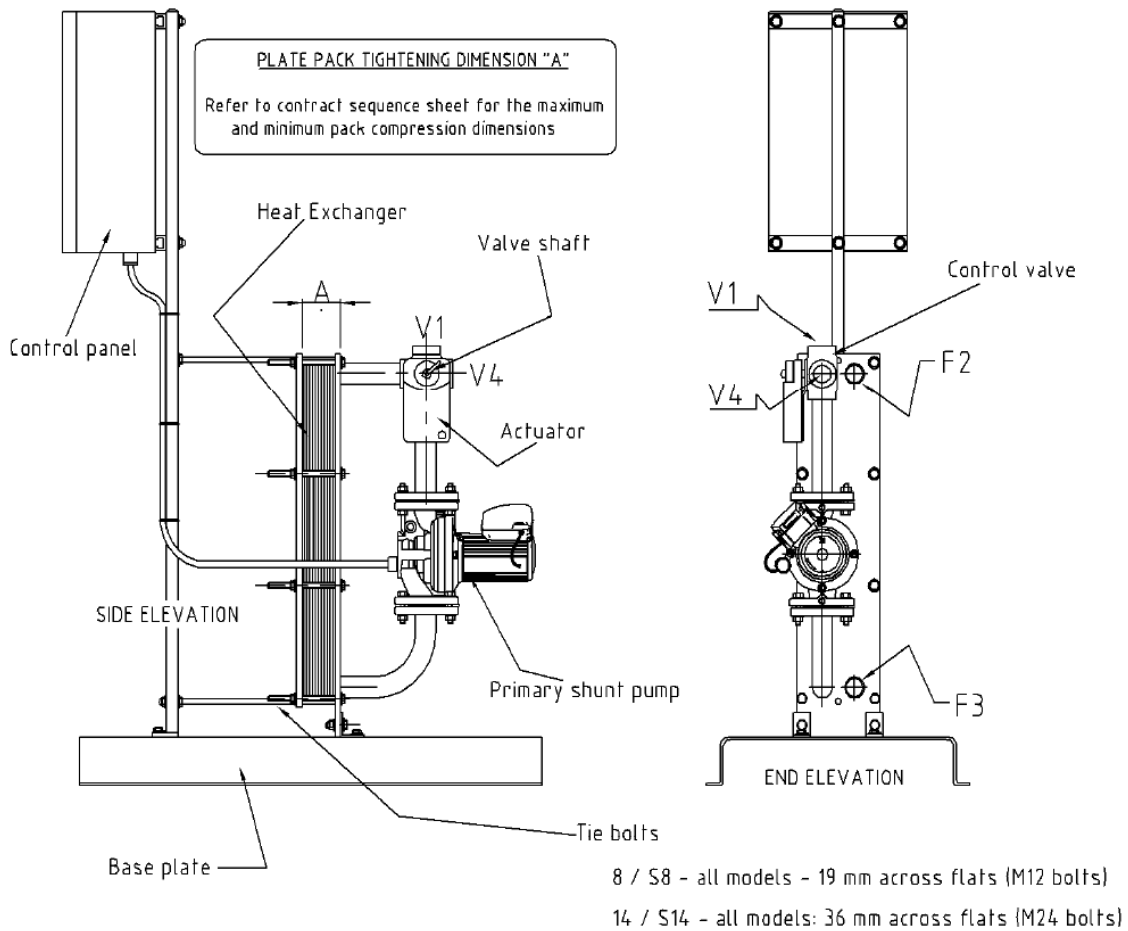

CONNECTION SIZE/TYPE

8 / S8 - all outputs	14/S14 - 400 to 650 kW	14/S14 - 700 to 1000 kW
V1: 1.25" BSPT Female	1.5" PN6 flanged	2.0" PN6 flanged
V4: 1.25" BSPT Female	1.5" PN6 flanged	2.0" PN6 flanged
F2: 1.25" BSPT Male	2.0" BSPT male	2.0" BSPT male
F3: 1.25" BSPT Male	2.0" BSPT male	2.0" BSPT male

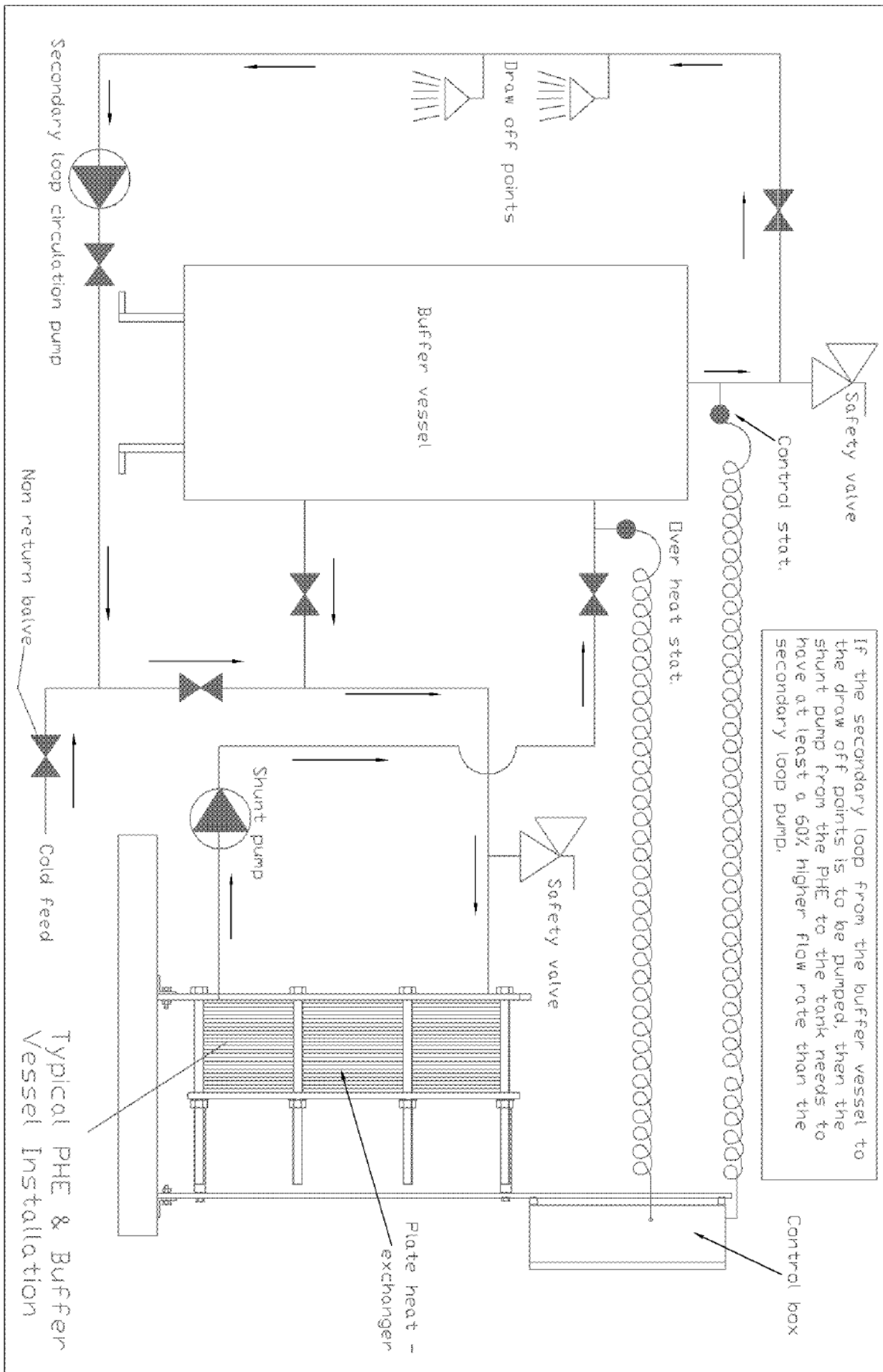





9. Setting up the controller & Start-up:

Shock: It is essential that the exchanger is not subjected to thermal or mechanical shock as this could lead to premature gasket failure.

Operation in automatic mode:

Once the pipe work and electrical connections have been made, all miniature circuit breakers (mcbs) located in the panel should be set to "on" and the system filled and vented.

The following procedure should then be followed to start the unit:

1. The control panel should be switched on at the main isolator. The "controls healthy" lamp on the control panel will be illuminated to indicate that the panel is live with the control voltage available.
2. Each pump is fitted with a "Hand/Off/Auto selector switch. If "Hand" is selected the relevant pump will run.
Similarly if "Off" is selected then the relevant pump will not run. If "Auto" is selected then the pump will run under the control of the time clock/BMS interface.
3. The temperature controller is factory set at 10% proportional span and 5 sec integral time (auto reset).
These settings should give reasonable results with most systems but, depending on the thermal response of the system, some adjustment may be needed. Any such adjustment should only be carried out by competent persons. Full controller instructions are given in appendix 1.
4. Adjustment of the temperature set point can be done as follows:
 - From the normal run mode press  .
 - The lower display will then show "SP" and the upper display will show the actual set point.
 - Press  or  to change the set point to the required value.
 - Finally, press  to return to normal run mode.
5. The time clock (not fitted on BMS controlled panels) is factory set to the correct day and time. Should this need alteration this can be done by pressing and holding the CLOCK key whilst pressing the DAY, HOUR or MIN keys until the correct values are shown. The time clock (if fitted) is also factory set to switch ON at 07.30 and OFF at 20.00 every day. Should this need alteration this can be done as follows:
 - Press TIMER key once to enter program mode, display will show "1 ON: __C1"
 - Press the DAY key to choose one of the 15 different day combinations (see table below) for the first ON time of channel 1.
 - Press the HOUR and MIN keys to select the desired first ON time for Channel 1
 - Press TIMER key once. Display will show "1 OFF: __C1". Repeat previous steps to set the desired first OFF time for channel 1.
 - Repeat the entire sequence to set up to four different ON/OFF times for channel 1.
 - When all required times are set press the CLOCK key to return to run mode.

NOTE: On panels fitted with a time clock, twin head pump(s), and auto head change over, channel two on the time clock is used within the panel to rotate the duty pump and should not be altered from factory settings. Should this inadvertently be done then it must be re-programmed as follows:

- Set the times for channel 1 as described above, once this is complete press the TIMER key so the display shows "1ON: __C2".
- Press the DAY key until 14 is selected.

- Set the ON time to 00.01 using the HOUR and MIN keys.
- Press the TIMER key so display shows "1OFF_:__C2".
- Set the OFF time to 23.59.
- Press CLOCK key to return to run mode.

Once all times are set the clock must be put into AUTO mode by repeatedly pressing the CH A MANUAL key and CH B MANUAL key until the indicator bar on the display is above the word AUTO for both channels.

Reviewing the existing program can be done by repeated pressing of the TIMER key. When done, press the CLOCK key to return to run mode.

Timed operation can be overridden by pressing the MANUAL key to move the indicator bar on the display to the desired position (ON, OFF or AUTO). Timed operation will not resume until the indicator bar is repositioned above the word AUTO.

All time clock adjustment can be done with the panel turned off.

Table showing on days for DAY key settings (X=on)

	1	2	3	4	5	6	7	8	9	10	11	12	13	14	15
Mon	X	X	X							X		X		X	
Tue	X	X		X						X		X			X
Wed	X	X			X					X		X		X	
Thur	X					X				X			X		X
Fri	X						X			X			X	X	
Sat	X							X			X		X		X
Sun	X								X		X				

10. Shutting down the Exchanger for Maintenance:

Shut down: Switch panel "OFF" at main isolator.
Allow unit to cool, close isolation valves, and drain heat exchanger.

Tools: Ratchet spanners and ring or open-ended spanners, plus light machine oil. M24 (36mm across flats)

Procedure:

- Ensure the control panel is isolated and all isolation valves on the pipe work are closed.
- Allow unit to cool, and drain exchanger.
- Release all pressure from inside of exchanger.
- Lightly oil the tie bolt threads down either side of the exchanger.
- Undo the clamping bolts uniformly - keep the frame plates as parallel as possible during this operation.
- Push / pull back the mobile frame plate away from plates pack & secure if necessary.
- Separate heat transfer plates carefully, avoiding damage to gaskets.

Use gloves to handle the plates - the edges can be sharp.

11. Cleaning of the plates:

Safety: Wear gloves & eye goggles when using cleaning detergents.

Brushing: Use nylon or other types of "soft" scrubbing brushes with detergent. **Never** use a metal brush, steel wool, or sand/glass paper.

Detergents: Consult a cleaning specialist for a suitable choice of detergent. Ensure that all detergents used are compatible with the plate and gasket material before use.

Plate material: 316 stainless steel
 Gasket material: Nitrile rubber, or EPDM.

12. Assembly:

- Refer to the Plate Sequence Sheet to determine the order of the plates, & the type required.
- Fit the start plate (see illustration on next page), ensuring the plate pattern is pointing in the correct direction as indicated on the plate sequence sheet.
- Fit plates in the correct order according to the Plate Sequence Sheet.
- Ensure all gaskets face towards the fixed / head frame plate (connection end).
- Alternate between left & right handed plates - if the plate edges form a regular honeycomb pattern, then the left / right hand sequence is correct (see illustration below for herringbone pattern example)

Assembly diagrams:

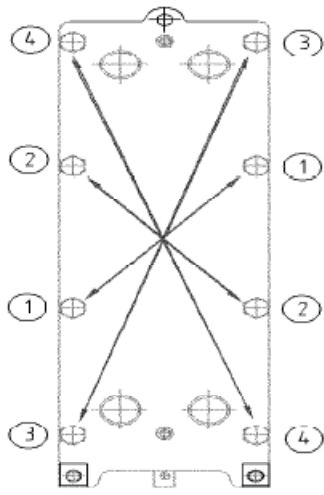
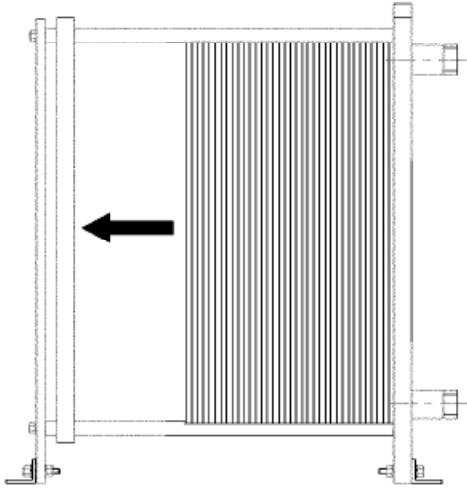
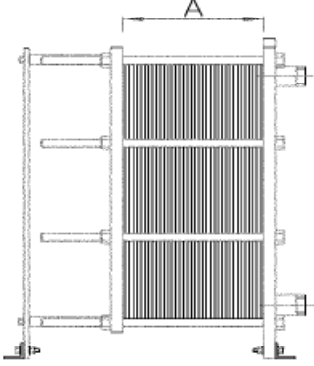
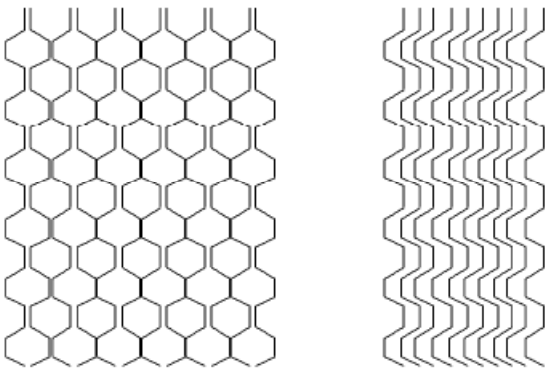
<p>BOLT TIGHTENING & LOOSENING SEQUENCE</p> 	<p>REMOVING HEAT TRANSFER PLATES</p> <p>REMOVE TIE BOLTS. OIL TOP FRAME BAR & SLIDE BACK FOLLOWER PLATE - BEWARE OF PLATES FALLING OUT. PLATES CAN BE TAKEN OUT DIAGONALLY BETWEEN THE FRAME BARS.</p> 
<p>PLATE PACK TIGHTENING DIMENSION / COMPRESSION LENGTH</p> 	<p>EXAMPLE OF THE PLATE PACK HERRINGBONE PATTERN</p> 

13. Tightening of the plate pack:

Procedure:

- Lightly oil tie bolt threads.
- Evenly tighten all bolts. We recommend the use of ratchet / friction spanners.
- Ensure clamping is as uniform as possible, thus keeping the frames plates parallel throughout the operation. Avoid skewing the frame plates by more than 10mm
- Tightening is complete when the distance between the inside faces of the two frame plates is within the compression length maximum and minimum dimensions as given on the plate pack sequence sheet.
- Finally check that all bolts are in tension, and clean any spilt oil off the frame plates.
- On completion, the unit can be pressure tested at no more than 6 bar g.

Examples of Gasket and Plate types:

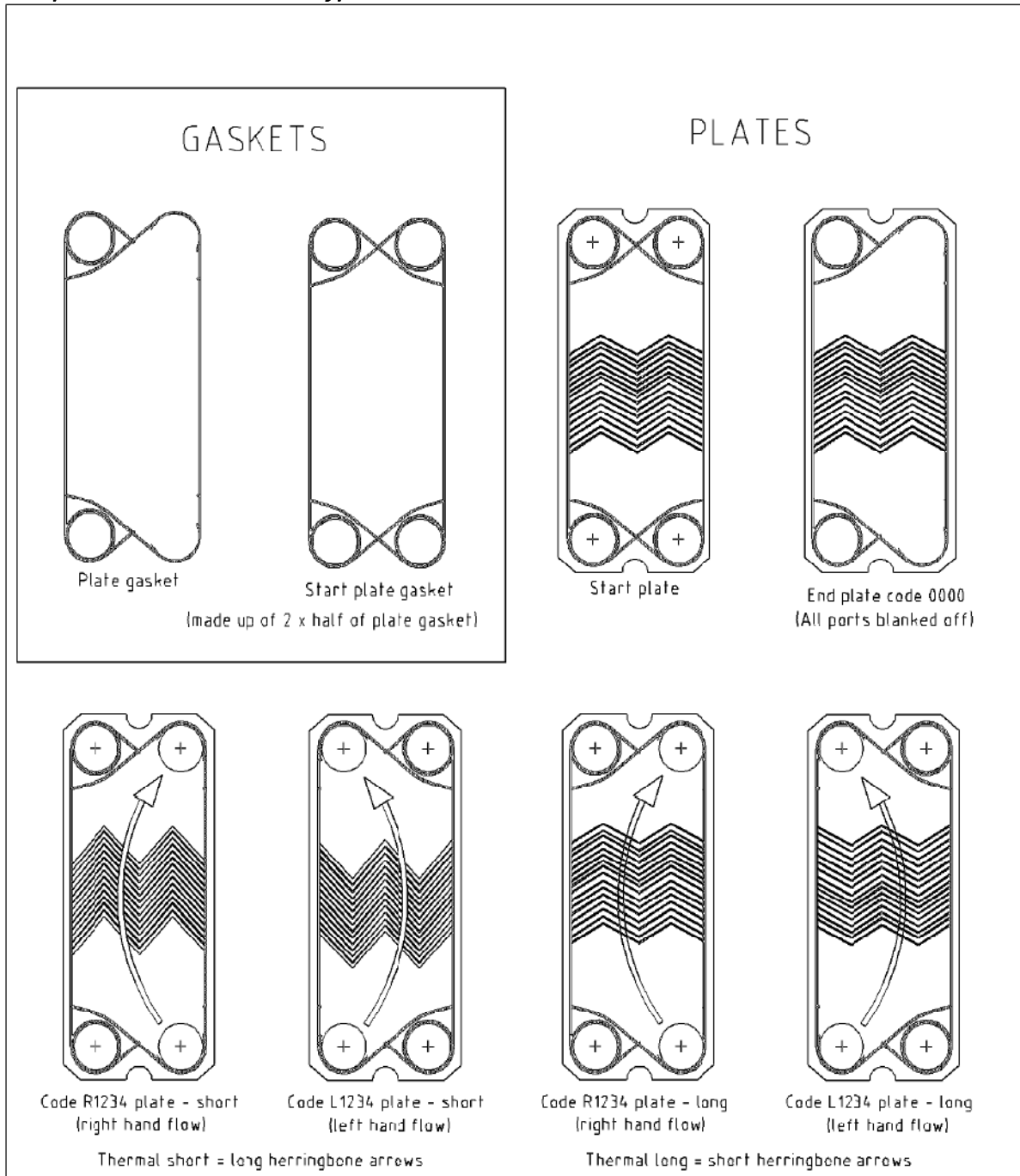

14. Trouble Shooting:

Heat Exchanger Plate Pack Assembly:

- | | |
|----------------------------------|---|
| 1) Nuts tight to turn: | insufficient oil on threads |
| 2) Plates move out of alignment: | remove plates & degrease, then dry.
inspect plate hanging system for damage. |

Excessive pressure drops:

- | | |
|-------------------------------------|---|
| 1) Liquid flows higher than design: | Check & adjust |
| 2) Plate channels blocked: | Back flush, C.I.P., or dismantle to clean. |
| 3) Inaccurate measurement: | Check pressure gauge for accuracy ensure measurement does not include any bend, valve / fitting, & pipe run losses. |
| 4) Liquid temp. below design: | Viscous media generate higher resistance to flow at lower temperatures. |
| 5) Media used not as per design: | The addition of glycol or other additives can increase the pressure drop. |

Leakage:

- | | |
|-----------------------------|--|
| 1) leakage near connection: | First heat transfer plate gasket damaged – dismantle heat exchanger plate pack, and check condition. If the threaded connections are rotated when in situ, damage can occur to the backing O-rings. Refer to connection tightening section of the manual.
Flange gaskets leaking – check / replace.
Crack in weld at joint – Dye Pen. Check and repair (remove plates out of heat exchanger before welding). |
| 2) cross contamination: | Check all plates for cracks and / or holes. |
| 3) leakage from plate pack: | Check tightening dimension.
Check condition of the gaskets.
Check that all gaskets are seated correctly. |

For nearly all leakage problems, it is necessary to dismantle the plate pack before any attempts to rectify the fault can be made. Mark the area(s) from where the leaks are occurring before taking apart the exchanger to assist in fault finding once plates are taken out of exchanger.

Decrease in the performance:

- 1) plate surfaces require cleaning or de-scaling.
- 2) pumps or associated controls have failed.
- 3) liquid flows not as per the design specification.
- 4) associated boiler under sized.
- 5) primary temperature lower than design figures.
- 6) Sensors faulty (check first that they are securely fastened around pipe work).
- 7) plate pack has been assembly incorrectly.
- 8) unit running in co-current flow, instead of counter current - check with contract

drawing and alter pipe work if necessary., and check direction of pump flows.
9) air lock has developed in the plate pack.

No Secondary Flow:

Possible Causes:

- a) Electrical Fault
- b) Pump Tripped (Trip Lamp illuminated on control panel)
- c) High Limit Shut Down (High Temp. Lamp illuminated on control panel facia)
- d) Air Lock in system
- e) Not in correct mode of operation.

Remedies:

- a) Check electrical supply to control panel together with the mcbs fitted within the panel
- b) Reset overload within the control panel using the blue reset button fitted on the relevant overload F112 is for primary pump 1
F132 is for primary pump 2 (only if fitted)
F152 is for secondary pump 1 (only if fitted)
F172 is for secondary pump 2 (only if fitted)
Should the pump fail to restart, a problem may exist elsewhere in the system and advice should be sought from the installer/supplier.
- c) The system will need to be reset after high limit shut down. Wait for a few minutes to allow the temperature to cool slightly and then press the manual re-set button. Should the problem fail to reset or frequently reoccur, advice should be sought from the installer/supplier.
- d) Vent air from system.
- e) Check Main Control Switch/Time clock.

Secondary Water Temperature too High / Low , or unit cuts out on over heat

Possible Causes:-

- a) Wrong set point on controller.
- b) Air Lock in pipe work.
- c) Primary water temperature too high or too low.
- d) Primary water flow too high / too low, or secondary flow not correct.
- e) Fault in temperature sensor.
- f) Actuator fault – the valve does not modulate, or move during operation..
- g) Control valve seized or binding
- h) Primary circuit pressure feeding PHE too high

Remedies:-

- a) Adjust Controller – see relevant section in manual
- b) Vent System
- c) Ensure that boiler or source of primary temperature water is functioning correctly & rectify as required.
- d) Ensure that primary and/or secondary water pump(s) / source is / are performing correctly & rectify as required.
- e) Electrician required – the sensor and the wires need to be checked. Isolate panel, then disconnect the temperature sensor wires (not the over heat stat) out of the panel and measure the resistance. The resistance should be around 110 ohms (depending on temperature. If a reading of "infinite" is shown then there is an open circuit, and the most likely cause is that the wires leading to and from the sensor are broken. If the reading is zero, then there is a short circuit in the circuit. Check / replace the wires/sensor.
- f) Actuator failed – remove from valve (see actuator replacement section). Alter set point to low temperature and check to see if actuator drive turns to fully closed position, and then alter set point to a high temperature and check to see if drive rotates a full 90

degrees from fully closed position. If no, or in-sufficient travel of the drive is observed, then actuator requires replacement.

g) Check for binding / seizure – remove actuator (see actuator removal section) and then try to rotate valve stem – you can use grips on the end of the stem as an aid but make sure that the stem is protected from damage from the grips. The valve should rotate freely through out the range of travel. Sediment build up can block the action of the valve and this rotating action can some times be enough to free the component. If binding persists then isolate the unit, shut down, and drain primary circuit. The inner parts of the valve can be removed without taking the complete valve off the pipe work:

Cast iron valve type

– loosen the 4 bolts on the side of the valve body and pull body back the side panel. This may require a lever, but try to avoid damage to the sealing face.

Inspect, clean and lubricate or replace with new components. If it looks as though the paddle is binding against the valve body then the paddle then any “proud” / high points can be shaved down by the use of wet and dry, or emery, paper.

Brass valve type,

-rotate the silver disk until the lugs on the disk are no longer underneath the brass noggins and then pull out the stem and valve paddle – there is a sealing O-ring which needs to be protected from damage. If the paddle is tight to remove then replace the central bolt into the stem and use the bolt to aid in pulling out the paddle part of the valve.

If it looks as though the paddle is binding against the valve body then the paddle then any “proud” / high points can be shaved down by the use of wet and dry, or emery, paper. A possible remedy without taking out valve inners may be to spray lubricant (such as WD40) onto valve shaft bearing (see section on control valve in Section 1 at beginning of manual) and then locate the stem a few times to work in the lubricant. If the pressure of the primary circuit is too high then it can be greater than what the primary shunt pump on the exchanger control loop can pump against. If this is the case, the primary shunt pump fails to pump back into the return loop of the main primary circuit as it is effectively “fighting” against the pressure of the primary circuit. The primary circuit pressure must be reduced to allow to the shunt pump to circulate water through the exchanger.

Primary or secondary Pump(s) fails to operate:

Possible Causes:-

- a) Circuit breaker tripped or set to “off” - Check circuit breakers inside panel .
- b) If pump tripped out of a fault then this could indicate a too high a Current – if the unit is new then check the direction of the pump rotation and check to see if the pipe work has been connected correctly – the over load setting can be adjusted – contact an electrician to undertake this work. The wiring diagram can be referred too to find the location of the overload and the factory setting. There is a scaled dial on the overload which can be rotated to increase/decrease the overload current – caution – too high an over load setting reduces the protection on the pump.
- c) Pump motor burnt out or faulty – contact the Sales Office for replacement parts.

Actuator Replacement:

- a) Switch off panel
- b) Un-do central bolt holding actuator to valve stem, and pull off complete actuator assembly.
- c) Remove small cross head screw holding actuator cover, remove cover, remove wire plug, and note position of the 3 (some times 4) small dip switches on the printed circuit board.
- d) Spray WD 40 or similar into valve stem bearing to lubricate valve and rotate a few times from left to right.

e) Remove cover on new actuator, and set the dip switches the same as the old unit, plug in wires, and refit actuator cover

f) Rotate control valve stem fully clockwise until it stops.

g) Switch on the panel, set temperature high to force the control system to rotate actuator to fully open position, install actuator and tighten screw (NOTE – ensure that the back of the actuator locks into the locating dowel protruding from the valve body) and then tighten the central screw.

Do not over tighten, and ensure that pointer is to the right (valve fully open), and that the actuator knob is fully pushed in.

h) Alter the control Set Point to a low temperature – actuator should move until stops at fully closed position. Then alter the control Set Point to a high temperature – actuator should move to fully open position. If all OK then re-set control temperature to desired value.

15. Maintenance:

Time interval: Once a year as a minimum.

Performance: Check temperatures and flows against commissioning data.

Plate pack: Check the tightening dimension, and look for any signs of leakage from heat exchanger.

Nozzles: Check general condition, and for any signs of leakage.

Frame: wipe clean all painted parts, and check surfaces for signs of damage - “touch up” if necessary.

Bolts & bars: Check for rust, and clean. Lightly coat threaded parts with molybdenum grease, or a corrosion inhibitor (ensure that no grease, etc. falls onto the plate gaskets).

Electrical: Check the security of all electrical connections and inspect the wiring for damage.

Actuator/valve: Spray WD40 or similar into valve spindle where it enters the valve..

16. Spare Parts:

To help identify the unit, it is necessary to quote the serial number as given on the nameplate. Replacement parts and other information can be obtained from:

MHG Heating Ltd Unit 4 Epsom Downs Metro Centre Waterfield Tadworth Surrey KT20 5LR
P: 08456 448802 F: 08456 448803 E: info@mhgheating.co.uk W: www.mhgheating.co.uk

17. Controller Setting Guide.

Parameter listing for Temperature Controller (For commissioning Engineers use only)

1/16 DIN PROCESS CONTROLLERS CONCISE PRODUCT MANUAL

CAUTION: Installation should be only performed by technically competent personnel. Local Regulations regarding electrical installation & safety must be observed.

SELECT MODE

Select mode is used to access the configuration and operation menu functions. It can be accessed at any time by holding down **⏏** and pressing **⏏**. In select mode, press **⏏** or **⏏** to choose the required mode, press **⏏** to enter. An unlock code is required to prevent unauthorised entry to Configuration & Setup modes. Press **⏏** or **⏏** to enter the unlock code, then press **⏏** to proceed.

Mode	Upper Display	Lower Display	Description	Default Unlock Codes
Operator	OPt_r	SLCt	Normal operation	None
Set Up	SEtP	SLCt	Tailor settings to the application	10
Configuration	ConF	SLCt	Configure the instrument for use	20
Product Info	Info	SLCt	Check manufacturing information	None
Auto-Tuning	Autun	SLCt	Invoke Pre-Tune or Self-Tune	0

Note: The instrument will always return automatically to Operator mode if there is no key activity for 2 minutes.

CONFIGURATION MODE

First select Configuration mode from Select mode (refer to section 2). Press **⏏** to scroll through the parameters, then press **⏏** or **⏏** to set the required value. Press **⏏** to accept the change, otherwise parameter will revert to previous value. To exit from Configuration mode, hold down **⏏** and press **⏏** to return to Select mode.

Note: Parameters displayed depends on how instrument has been configured. Refer to user guide (available from your supplier) for further details. Parameters marked * are repeated in Setup Mode.

Parameter	Lower Display	Upper Display	Adjustment range & Description	Default Value
Input Range Type	irPt		PT 100 sensor	PtC
Scale Range Upper Limit	rUL		Scale Range Lower Limit +100 to Range Maximum	100
Scale Range Lower Limit	rLL		Range Minimum to Scale Range Upper Limit -100	0
Decimal point position	dPoS		0=XXXX, 1=XXX.X, 2=XX.XX, 3=X.XXX (non-temperature ranges only)	1
Control Type	CtYP	SnGL	Primary only	SnGL
Primary Output Control Action	Ct_rL	rEv	Primary & Secondary (c.g. heat & cool)	rEv
		d_r	Reverse Acting	
		P_H	Direct Actng	
Alarm 1 Type		P_Lo	Process High Alarm	P_H
		dE	Process Low Alarm	
		bAnd	Deviation Alarm	
		nonE	Band Alarm	
High Alarm 1 value*	PhA1		Range Minimum to Range Maximum in display units	Range Max
Low Alarm 1 value*	PLA1			Range Min
Band Alarm 1 value*	bAL1		1 LSD to span from setpoint in display units	5
Dev. Alarm 1 value*	dAL1		+/- Span from setpoint in display units	5
Alarm 1 Hysteresis*	AHY1		1 LSD to full span in display units	1
Alarm 2 Type*	ALAC		Options as for alarm 1	P_Lo



High Alarm 2 value*	PhA2			Range Max		
Low Alarm 2 value*	PLA2			Range Min		
Band Alarm 2 value*	bAL2			5		
Dev. Alarm 2 Value*	dAL2			5		
Alarm 2 Hysteresis*	AHY2		Options as for alarm 1	1		
Loop Alarm	LAEn		d.SA (disabled) or EnAb (enabled)	d.SA		
Loop Alarm Time*	LALt		1 sec to 99 mins. 59secs	99.59		
Alarm Inhibit:		nonE	No alarms inhibited	nonE		
		ALA1	Alarm 1 inhibited			
		ALA2	Alarm 2 inhibited			
		both	Alarm 1 and alarm 2 inhibited			
Output 1 Usage		Pr_r	Primary Power	Pr_r		
		SEc	Secondary Power			
		A1_d	Alarm 1, Direct			
		A1_r	Alarm 1, Reverse			
		A2_d	Alarm 2, Direct			
		A2_r	Alarm 2, Reverse			
		LP_d	Loop Alarm, Direct			
		LP_r	Loop Alarm, Reverse			
		Or_d	Logical Alarm 1 OR 2, Direct			
		Or_r	Logical Alarm 1 OR 2, Reverse			
Linear Output 1 Range		0_5	0 to 5 V DC output	0_10		
		0_10	0 to 10 V DC output			
		2_10	2 to 10 V DC output			
		0_20	0 to 20 mA DC output			
		4_20	4 to 20 mA DC output			
	Retransmit Output 1 Scale maximum	ro1H			-1999 to 9999 (display value at which output will be maximum)	Range max
	Retransmit Output 1 Scale minimum	ro1L			-1999 to 9999 (display value at which output will be minimum)	Range min
	Output 2 Usage	USE2			As for output 1	Sec or Al2
	Linear Output 2 Range	tYP2			As for output 1	0_10
	Retransmit Output 2 Scale maximum	ro2H			-1999 to 9999 (display value at which output will be maximum)	Range max
Retransmit Output 2 Scale minimum	ro2L		-1999 to 9999 (display value at which output will be minimum)	Range min		
Output 3 Usage	USE3		As for output 1	A1_d		
Linear Output 3 Range	tYP3		As for output 1	0_10		
Retransmit Output 3 Scale maximum	ro3H		-1999 to 9999 (display value at which output will be maximum)	Range max		
Display Strategy	dISP		1, 2, 3, 4, 5 or 6 (refer to section 8)	1		
Serial Communications Protocol		ASC1	ASCII	P7bn		
		P7bn	Modbus with no parity			
		P7bE	Modbus with Even Parity			
		P7bo	Modbus with Odd Parity			
Serial Communications Bit Rate		1.2	1.2 kbps	4.8		
		2.4	2.4 kbps			
		4.8	4.8 kbps			
		9.6	9.6 kbps			
Comms Address	Addr		1 to 255 (Modbus), 1 to 99 (ASCII)	1		
Comms Write		r_Wr	Read/Write	r_Wr		
		r_0	Read only			
Digital Input 1 Usage	dIG1		d.S1 Setpoint 1 / Setpoint 2 select*	d.S1		
Digital Input 2 Usage		d.rS1	Automatic / Manual select	d.rS1		
		d.iS1	Setpoint 1 / Setpoint 2 select*			

Usage	Remote Setpoint Input Range	d rAS	Automatic / Manual select	0..10	
		d rRS	Remote / Local setpoint select		
		0..20	0 to 20 mA DC input		
		4..20	4 to 20 mA DC input		
		0..10	0 to 10 V DC input		
		2..10	2 to 10 V DC input		
		0..5	0 to 5 V DC input		
		1..5	1 to 5 V DC input		
		100	0 to 100mV DC input		Available on full RSP (S1ct E) only
		Pot	Potentiometer (2KΩ minimum)		
RSP Upper Limit	rSPu	-1999 to 9999	Range max		
RSP Lower Limit	rSPL	-1999 to 9999	Range min		
RSP Offset	rSPo	Constrained within Scale Range Upper & Scale Range Lower limits	0		
Configuration Lock Code	CLoc	0 to 9999	20		

Auto/manual Control selection	PoEn	EnAb (enabled)	
Setpoint Select shown in Operator Mode	SSEn		
Setpoint ramp adjustment shown in Operator Mode	SPr		
SP Ramp Rate Value	rP	1 to 9999 units/hour or Off (blank)	Off
Setpoint Value	SP	Scale range upper to lower limits. (when dual or remote setpoint options are used, SP is replaced by SP 1 & SP 2 or LSP - or E before the legend indicates the currently active SP)	Scale Range Minimum
Local Setpoint Value	LSP		
Setpoint 1 Value	_SP 1		
Setpoint 2 Value	_SP 2		
Setup Lock Code	SLoc		

SETUP MODE

Note: Configuration must be completed before adjusting Setup parameters.

First select Setup mode from Select mode (refer to section 2). The MAN LED  will light while in Setup mode. Press  to scroll through the parameters, then press  to set the required value.

To exit from Setup mode, hold down  and press  to return to Select mode.



Note: Parameters displayed depends on how instrument has been configured.



Parameter	Lower Display	Upper Display Adjustment Range & Description	Default Value
Input Filter Time Constant	F ILT	OFF or 0.5 to 100.0 secs	2.0
Process Variable Offset	OFFS	±Span of controller	0
Primary Power	PPuJ	Current power levels (read only)	N/A
Secondary Power	SPuJ		
Primary Proportional Band	Pb_P	0.0% (ON/OFF) and 0.5% to 999.9% of input span	10.0
Secondary Proportional Band	Pb_S		
Automatic Reset (Integral Time)	RrSt	1 sec to 99 mins 59 secs and OFF	5.00
Rate (Derivative Time)	rRtE	00 secs to 99 mins 59 secs	1.15
Overlap/Deadband	DL	-20 to +20% of Primary and Secondary Proportional Band	0
Manual Reset (Bias)	b rAS	0%(-100% if dual control) to 100%	25
Primary ON/OFF Differential	d rFP	0.1% to 10.0% of input span centered about the setpoint. (Entered as a percentage of span)	0.5
Secondary ON/OFF Diff.	d rFS		
Prim & Sec. ON/OFF Differential	d rFF		
Setpoint Upper Limit	SPuL	Current Setpoint to Range max	R/max
Setpoint Lower limit	SPLL	Range min to Current Setpoint	R/min
Primary Output Power Limit	OPuL	0% to 100% of full power	100
Output 1 Cycle Time	Ct 1	0.5 1, 2, 4, 8, 16, 32, 64, 128, 256 or 512 secs.	32
Output 2 Cycle Time	Ct 2		
Output 3 Cycle Time	Ct 3		
High Alarm 1 value	PhA 1	Range Minimum to Range Maximum	R/max
Low Alarm 1 value	PLA 1		R/min
Deviation Alarm 1 Value	dAL 1	±Span from SP in display units	5
Band Alarm 1 value	bAL 1	1 LSD to span from setpoint	5
Alarm 1 Hysteresis	AHY 1	1 LSD to full span in display units	1
High Alarm 2 value	PhA 2	Range Minimum to Range Maximum	R/max
Low Alarm 2 value	PLA 2		R/min
Deviation Alarm 2 Value	dAL 2	±Span from SP in display units	5
Band Alarm 2 value	bAL 2	1 LSD to span from setpoint	5
Alarm 2 Hysteresis	AHY 2	1 LSD to full span in display units	1
Loop Alarm 1 time	LA 1	1 LSD to full span in display units	99.59

Auto Pre-tune	APt	d rSA (disabled) or	d rSA
---------------	------------	----------------------------	--------------

AUTOMATIC TUNING MODE

First select Automatic tuning mode from Select mode (refer to section 2).

Press  to scroll through the modes, then press  or  to set the required value.

To exit from Automatic tuning mode, hold down  and press  to return to Select mode.

Pre-tune is a single-shot routine and is thus self-disengaging when complete.

If **APt** in Setup mode = **EnAb**, Pre-tune will attempt to run at every power up*. Refer to the full user guide (available from your supplier) for details on controller tuning.

Parameter	Lower Display	Upper Display	Default Value
Pre-Tune	Ptun	On or OFF. Indication remains OFF if automatic tuning cannot be used at this time*	OFF
Self-Tune	Stun		
Tune Lock	tLoc	0 to 9999	0

Note: Automatic tuning will not engage if either proportional band = 0. Also, Pre-tune will not engage if setpoint is ramping, or the PV is less than 5% of input span from the setpoint.

PRODUCT INFORMATION

First select Product information mode from Select mode (refer to section 2).

Press **[F1]** to view each parameter. To exit from Product Information mode, hold down **[F1]** and press **[F2]** to return to Select mode.

Parameter	Lower Display	Upper Display	Description
Input type	In_1	Un_1	Universal input
Option 1 module type fitted	OPn1	nonE	No option fitted
		rLY	Relay output
		SSr	SSR drive output
		tr_1	Triac output
Option 2 module type fitted	OPn2	L_in	Linear DC voltage / current output
			As Option 1
Option 3 module type fitted	OPn3	nonE	No option fitted
		rLY	Relay output
		SSr	SSR drive output
		L_in	Linear DC voltage / current output
		dc24	Transmitter power supply
Auxiliary Option A module type fitted	OPnA	nonE	No option fitted
		r485	RS485 communications
		d_iG_1	Digital Input*
		rSP_1	Remote Setpoint Input (basic)*
Auxiliary Option B module type fitted	OPnB	nonE	No option fitted
		rSP_1	Remote Setpoint Input (full) and Digital Input 2*
Firmware type	FUJ		Value displayed is firmware type number
Firmware issue	ISS		Value displayed is firmware issue number
Product Revision Level	P_rL		Value displayed is Product Revision level
Date of manufacture	d0r7		Manufacturing date code (mmyy)
Serial number 1	S_n1		First four digits of serial number
Serial number 2	S_n2		Middle four digits of serial number
Serial number 3	S_n3		Last four digits of serial number

Messages & ERROR INDICATIONS

These messages indicate that an error has occurred or there is a problem with the process variable signal or its wiring.

Caution: Do not continue with the process until the issue is resolved.

Parameter	Upper Display	Lower Display	Description
Instrument parameters are in default conditions	GoTo	ConF	Configuration & Setup required. This screen is seen at first turn on, or if hardware configuration has been changed. Press [F1] to enter the Configuration Mode, next press [F2] or [F3] to enter the unlock code number, then press [F1] to proceed
Input Over Range	[HH]	Normal	Process variable input > 5% over-range
Input Under Range	[LL]	Normal	Process variable input > 5% under-range
Input Sensor Break	OPEN	Normal	Break detected in process variable input sensor or wiring
RSP Over Range	[HH]**	Normal	RSP input over-range
RSP Under Range	[LL]**	Normal	RSP input under-range
RSP Break	OPEN**	Normal	Break detected in RSP input signal
Option 1 Error		OPn1	Option 1 module fault
Option 2 Error		OPn2	Option 2 module fault
Option 3 Error		OPn3	Option 3 module fault
Option A Error		OPnA	Option A module fault or RSP in both A & B
Option B Error		OPnB	Option B module fault

OPERATOR MODE

This mode is entered at power on, or accessed from Select mode (see section 2).

Note: All Configuration mode and Setup mode parameters must be set as required before starting normal operations.

Press **[F1]** to scroll through the parameters, then press **[F2]** or **[F3]** to set the required value.

Note: All Operator Mode parameters in Display strategy 6 are read only (see d_iSP in configuration mode), they can only be adjusted via Setup mode.

Upper Display	Lower Display	Display Strategy and When Visible	Description
PV Value	Active SP Value	1 & 2 (initial screen)	PV and target value of selected SP Local Setpoints are adjustable in Strategy 2
PV Value	Actual SP Value	3 & 6 (initial screen)	PV and actual value of selected SP (e.g. ramping SP value). Read only
PV Value	(Blank)	4 (initial screen)	Process variable only Read only
Active SP Value	(Blank)	5 (initial screen)	Target value of selected setpoint only. Read only
SP Value	SP	1, 3, 4, 5 & 6 if digital input is not d_iS1 and RSP not fitted	Target value of SP Adjustable except in Strategy 6
SP1 Value	.SP1	Digital input = d_iS1 lit if active SP = SP1	Target value of SP1 Adjustable except in Strategy 6
SP2 Value	.SP2	Digital input = d_iS1 lit if active SP = SP2	Target value of SP2 Adjustable except in Strategy 6
Local SP Value	.LSP	RSP fitted. - or lit if the active SP = LSP	Target value of local setpoint Adjustable except in Strategy 6
Remote SP Value	.rSP	RSP fitted. - or lit if the active SP = rSP	Target value of remote setpoint Read only
d_iG_1, LSP or rSP	SPS	RSP is fitted, digital input is not d_iS1 and SSEN is enabled in Setup mode	Selects local/remote active setpoint LSP = local SP, rSP = remote SP d_iG_1 = selection via digital input (if configured). Note: selecting LSP or rSP will override digital input, active SP indication changes to lit Adjustable except in Strategy 6
Actual SP Value	SP_rP	rP is not blank	Actual (ramping) value of selected SP. Read only
Ramp Rate	rP	SP_r enabled in Setup mode	SP ramping rate, in units per hour Adjustable except in Strategy 6

Manual Control

If PoEn is set to EnAb in Setup mode, manual control can be selected/de-selected by pressing the **[MAN]** key in Operator mode, or by changing the status of a digital input if d_iG_1 or d_iG_2 have been configured for d_iAS in Configuration mode.

While in Manual Control mode, the **[MAN]** indicator will flash and the lower display will show P_{xxx} (where xxx is the current manual power level). Switching to/from manual mode is via Bumpless Transfer. Press **[F2]** or **[F3]** to set the required output power.

Caution: Manual power level is not restricted by the OPuL power limit.